

***SEKONIC***

**Super Zoom Master**

**L-608/L-608 *CINE***

**Operating Manual**

Blank page

# *Congratulations on your purchase of a Sekonic Super Zoom Master L-608/L-608CINE Exposure Meter.*

The Super Zoom Master L-608/L-608CINE is the latest addition to the extensive line of Sekonic Exposure Meters which have been market leaders.

It was designed to be the ultimate meter, a do-all instrument for the most demanding pros.

It is the first zoom spot meter with digital spot viewfinder readout on the market. Nine camera-quality lens elements are required to accomplish its 1° to 4° zoom range.

its sealed housing and controls make it water and moisture resistant.

Yes, you can use it in the rain, but it is not an underwater meter.

The large LCD display makes reading easy, and it lights up automatically in dark surroundings.

In order not to crowd the controls, four functions which are less frequently used, are confined to DIP switches, located in the battery compartment.

Because of its many features, the L-608/L-608CINE requires this rather extensive manual. But since you will never use all of the function at the same time, once you have learned all about it, it is simple and its use will become second nature.

The Super Zoom Master L-608/L-608CINE has undergone extensive quality controls at every step of manufacture. Please read this instruction manual thoroughly, to be able to take advantage of its many features and to obtain the long service life it is designed for.

Thank you for your confidence in Sekonic.

# Table of Contents

---

1. Parts Designation .....	1
2. Explanation of the Liquid Crystal Display (LCD) .....	2-3
3. Before Using .....	4-6
1. Attach the strap .....	4
2. Inserting the battery .....	4
3. Checking battery capacity .....	4
4. Replacing battery during measurement or when using the memory function .....	5
5. Auto Power Off function .....	5
6. Setting main ISO film speed .....	5
7. Setting second ISO film speed (ISO 2) .....	5
8. Measurement Lock and Measurement Lock Off .....	6
4. Basic Operation .....	7-12
1. Incident or reflected spot measuring .....	7
2. Setting measuring mode .....	8
3. Setting DIP switches .....	9
4. When set for incident light .....	10
5. When set for reflected light (spot metering) .....	11
5. Measurement .....	13-22
1. Measuring Ambient Light .....	13
1-1 Shutter Speed Priority mode .....	13
1-2 Aperture Priority mode .....	14
1-3 EV mode .....	15
1-4 Cinematography .....	16
2. Measuring Flash Light .....	18
2-1 Cord Flash mode .....	18
2-2 Auto Reset Cordless Flash mode .....	19
2-3 Cord Multiple Flash (cumulative) mode .....	21
2-4 Cordless Multiple Flash (cumulative) mode .....	22
6. Advanced Functions .....	24-35
1. Memory function .....	24
2. Averaging function .....	25
3. Brightness Difference function .....	25
4. How to use an incident Illuminance (LUX or FC) Meter .....	27
5. How to use a reflected luminance (cd/m <sup>2</sup> or FL) meter .....	28
6. How to use Exposure compensation function .....	29
7. How to use Calibration compensation function .....	30
8. Filter compensation .....	31
9. Flash analyzing function .....	32
10. Custom setting function .....	33
11. Wireless flash radio triggering system .....	35
7. Accessories .....	38-39
8. Technical Data .....	40-41
9. Safety Guide .....	42
10. Care and Maintenance .....	43

# 1. Parts Designation

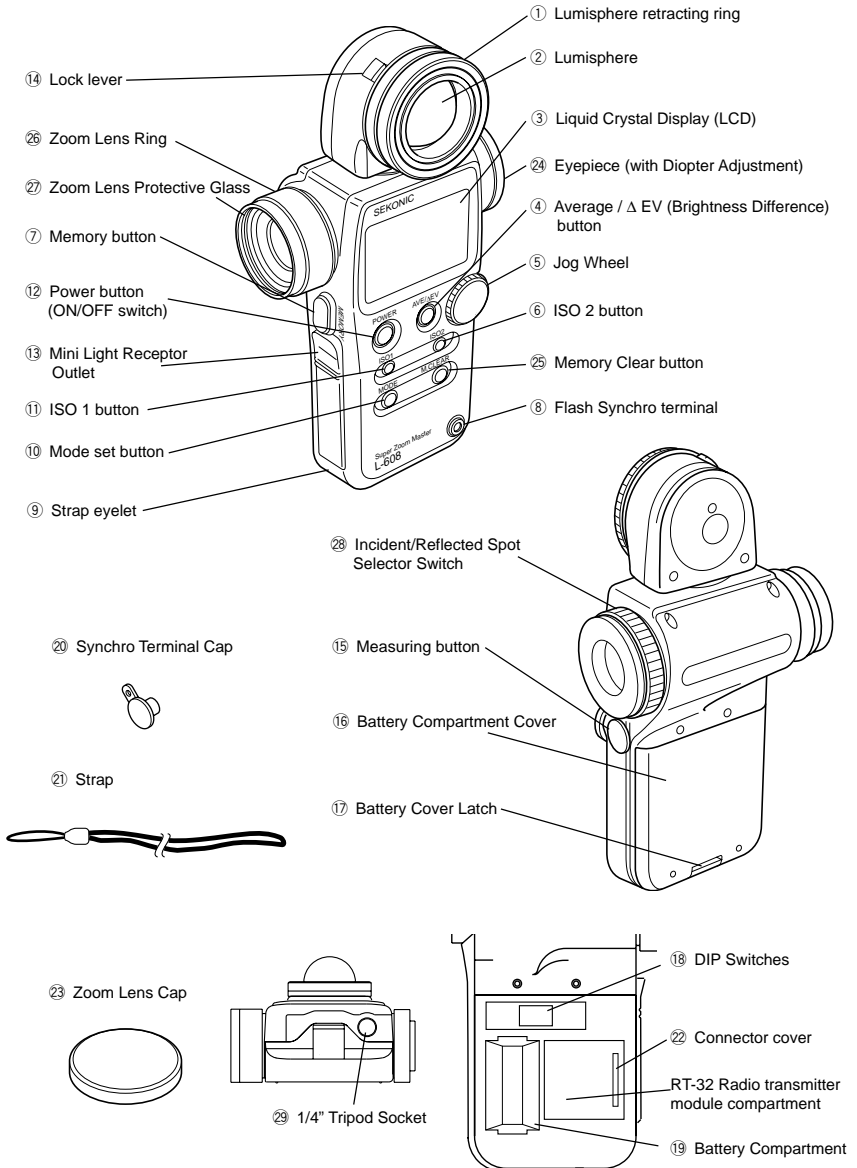

## 2. Explanation of the Liquid Crystal Display

L-608

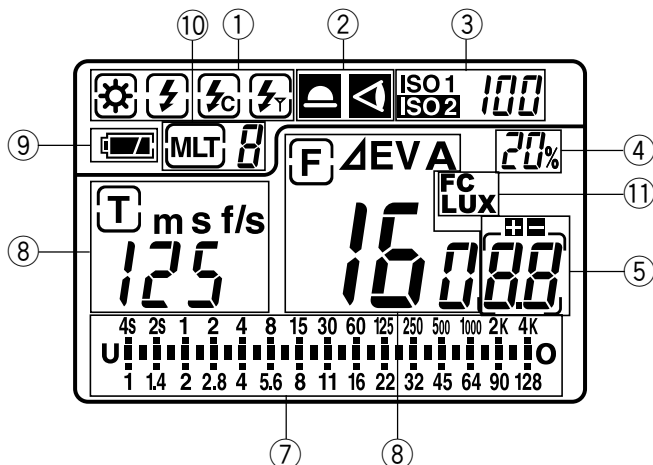

L-608CINE

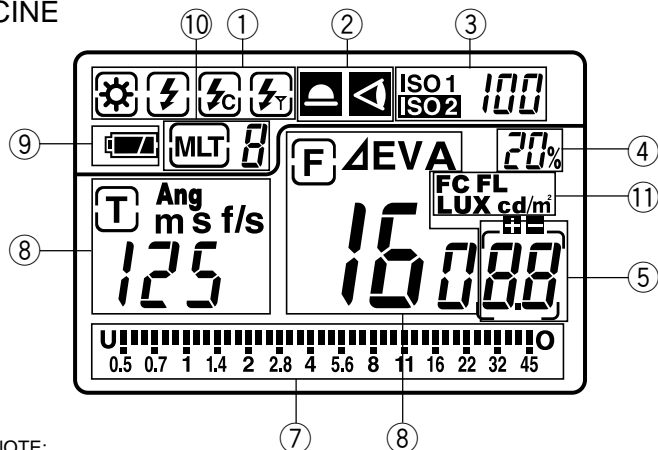













**NOTE:**

For explanation purposes, the display illustrated here shows all icons and readouts simultaneously. Actual display will never show as above.

**Auto Electro-Luminescent Display (EL)**

- In low light (EV 3 or less), a green backlight will automatically illuminate the entire LCD. When using the Mini Light Receptor or a Booster (optional accessories) the LCD will be illuminated after measuring, regardless of the ambient light level.
- The LCD will not be automatically illuminated during measuring, in Cordless Flash mode or Wireless flash radio triggering mode.
- The Electro-luminescent backlight will automatically turn off 20 seconds after last operation.

## 2. Explanation of the Liquid Crystal Display

- ① Measuring Mode Icons
  -  Ambient (see page 13)
  -  Auto-Reset Cordless Flash (see page 19)
  -  Cord Flash (see page 18)
  -  Wireless flash radio triggering mode (see page 35)
- ② Incident / Reflected Spot Function Icons (see page 7)
  -  Appears when in Incident mode
  -  Appears when in Reflected Spot mode
- ③ ISO Display
  - ISO 1** Displays ISO film setting
  - ISO 2** Displays second ISO film setting when ISO 2 button is pressed
- ④ Flash Analyzing indicator
  - %** 0 to 100% in 10% increments (percentage of the flash in the total exposure)
- ⑤ +/- Compensation Indicator
  -  Appears when +/- Compensation is set
- ⑥ Digital aperture value, Aperture Priority, EV Brightness Difference, Average function, EV display
  -  Appears when in Aperture Priority (f/stop) mode (see page 14)
  - ΔEV** Appears when using brightness difference function (See Page 25)
  - A** Appears when using Averaging function (see page 25)
  - EV** Appears when using EV mode (see page 15)
- ⑦ Analog Scale
  - Displays marks at apertures or shutter speed indicating full or half stop values (608), or full or 1/3 stop values (608 CINE) for measurement, also displays memory and average values
  - U** Appears when below display range
  -  Blinks when under exposed below measurement range
  - O** Appears when above display range
  -  Blinks when over exposed above measurement range
- ⑧ Shutter priority indicator, shutter speed display for still photography or frames per second (f/s) for cinematography
  -  Appears when Shutter Priority (T) mode (see page 13)
  - m** Appears when shutter speed is in minutes
  - s** Appears when shutter speed is in full seconds
  - f/s** Appears when cine speed is set in frames per second (see page 16)
  - Ang** Appears when shutter angle is set to a value other than 180 degrees (608 CINE)(see page 17)
- ⑨ Battery Power Indicator (see page 4)
- ⑩ Memory / Multiple Flash Indicator Display
  -  Appears when Multi (cumulative) flash measurement mode and shows the cumulated number of measurements (see page 21)
  - m**  Appears when reading is memorized and shows the number in memory (see page 24)
- ⑪ Illumination mark/brightness mark
  - FC** Appears when Foot-Candle is selected (608/608 CINE)
  - LUX** Appears when Lux is selected (608/608 CINE)
  - FL** Appears when Foot-Lambert is selected (608 CINE)
  - cd/m<sup>2</sup>** Appears when Cd/m<sup>2</sup> is selected (608 CINE)

## 3. Before Using

### 1. Attach the strap

Attach the Strap ⑫ by passing the small end loop through the eyelet ⑨ and passing the other end of strap through it.

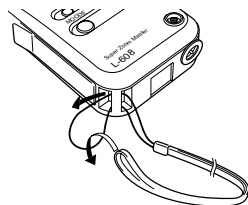

### ⚠ WARNING

- Place in a location where an infant cannot reach and accidentally get the strap wrapped around his or her neck. There is danger of strangulation.

### 2. Inserting the battery

1. Requires one 3.0 v CR123A lithium battery.
2. Open the Battery compartment cover latch ⑰, and remove the Battery compartment cover ⑱.
3. Insert the battery, observing the polarity with the +,- marks in the battery chamber.
4. Align the tabs of the Battery compartment cover with the notches in the back of the meter, and press down to close the Battery cover latch.

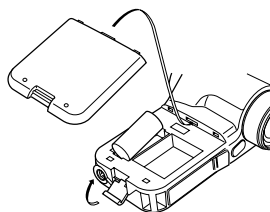

### NOTE:

- To prevent loss of All-weather seal, be careful that dirt does not get stuck on the rubber seal and that the seal is not damaged.
- Remove battery if meter is not used for an extended period. Batteries can leak and damage the exposure meter. Dispose of used batteries properly.
- If the LCD does not light, check that the battery capacity is sufficient, and check that the battery positive and negative terminals are not reversed.
- The meter has a connector for a plug-in radio transmitter module. Do not remove the connector cover unless you are installing the radio module, failure to do so could cause the electronic circuit board to be exposed to damaging static electricity.

### 3. Checking battery capacity

- When the Power button ⑫ is ON, the battery power indicator on the LCD is displayed.



(Displayed) Battery power level is good.



(Displayed) Battery power level is low. Have a spare battery ready.



(Blinking) Replace battery immediately.

### Reference:

- We recommend you always have a spare battery on hand.
- If the liquid crystal display extinguishes immediately after the display appears when power is first applied, that is an indication that the battery is dead. Please promptly replace the battery.
- A3 second pause between power on and off is recommended to avoid damage to the meter.



#### 4. Replacing battery during measurement or when using the memory function

1. Always turn the power OFF before replacing batteries. If batteries are removed with the power ON, measurements and settings in memory can no longer be recalled.
2. If after replacing the battery, or during measurements, strange screens (displays that have not been set) appear in the LCD, or nothing happens, no matter what button is pushed, remove the battery and wait at least ten seconds and then replace the battery. This allows the software to automatically reset.

#### WARNING:

- Never place batteries in fire, short, disassemble, or heat them. The batteries might break down, and cause an accident, injury or pollute the environment.



#### 5. Auto Power Off function

1. To conserve battery power, the meter will turn off about twenty minutes after last use.
2. Whether the Auto Power Saving feature turns the power off or the Power button  is pressed, the settings and measured values remain stored in memory. When the Power button is pressed again the last settings are displayed.

Reference:

- The power shuts off automatically after 1 minute when the power button is pressed and held.

#### 6. Setting main ISO film speed

1. Hold down the ISO1 button  and turn the Jog wheel  to select ISO film speed for the film being used.
2. You can also change the ISO film speed after taking measurements. The new value is automatically displayed.

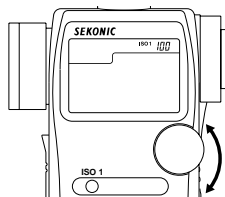

#### 7. Setting second ISO film speed (ISO 2)

1. This feature is useful when using a second film with different ISO film speed, using Polaroid™ proofing film, or for exposure correction (when using a filter, close-up photography, etc.).
2. Hold down the ISO 2 button  and turn the Jog wheel to select ISO film speed of the film being used.
3. Once this is set, after taking a measurement, the measured value for the second film speed will be displayed when the ISO 2 button is pressed.
4. You can also change the second ISO film speed after taking measurements. The new value is automatically displayed.

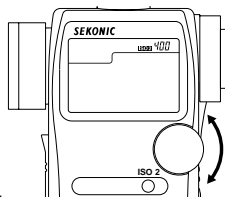

Reference:

- The following settings are possible when using custom setting function P33.
  1. It is possible to set the Filter compensation within a range of  $\pm 5$  EV in 1/10 steps.
  2. Filter factor number compensation enables you to set seven types of filters frequently used in the CINE industry. (Kodak Wratten Filters)(608 CINE only)

### 3. Before Using

---

#### 8. Mode and Setting Lock or Lock Off

1. Hold down the Mode set button ⑩ and ISO1 button ⑪ and "LOC" will appear to indicate that the Settings are locked. The last measurement is held until the lock is released, even if the Jog wheel ⑤ is accidentally moved.

However, if the measurement button ⑮ is pressed, a new measurement is displayed with the same locked settings.

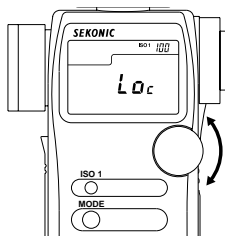

2. To release the Measurement lock, perform the same operation for the Measurement lock, Hold down the Mode set button and ISO1 button and "Off" will appear to indicate that the Measurement lock is released.

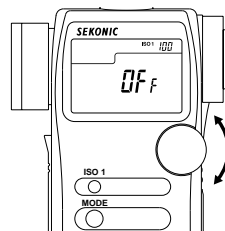

#### Reference:

- If power to the meter is turned off or auto off is activated when in the locked position, the dial lock function will continue operating when the meter is turned on again.

## 4. Basic Operation

### 1. Incident or reflected spot measuring

1. To set for either incident or reflected light operation, turn the Incident / Reflected Spot Selector Switch 28 on the eye piece, to the desired position (◀ or ▶ mark) until it clicks.

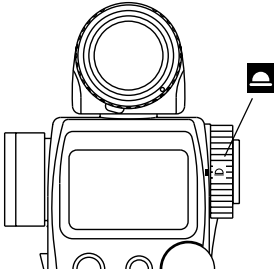

Incident operation

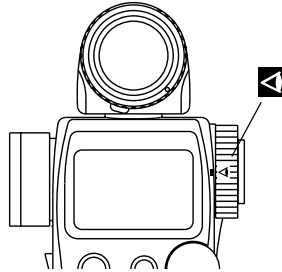

Reflected Spot operation

2. When incident operation is selected, the ▶ mark will blink for three seconds and when Reflected Spot operation is selected the ◀ mark will blink for three seconds on the LCD.

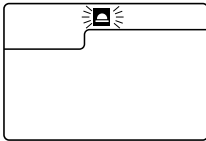

Incident operation

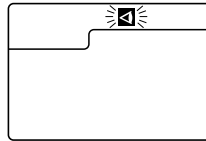



Reflected Spot operation

#### NOTE:



- Before taking measurements, always make sure that the desired measurement mode (▶ or ◀) is chosen by checking the LCD or that the Incident/Reflected Spot Selector Switch is clicked in proper position.

## 4. Basic Operation

### 2. Setting measuring mode

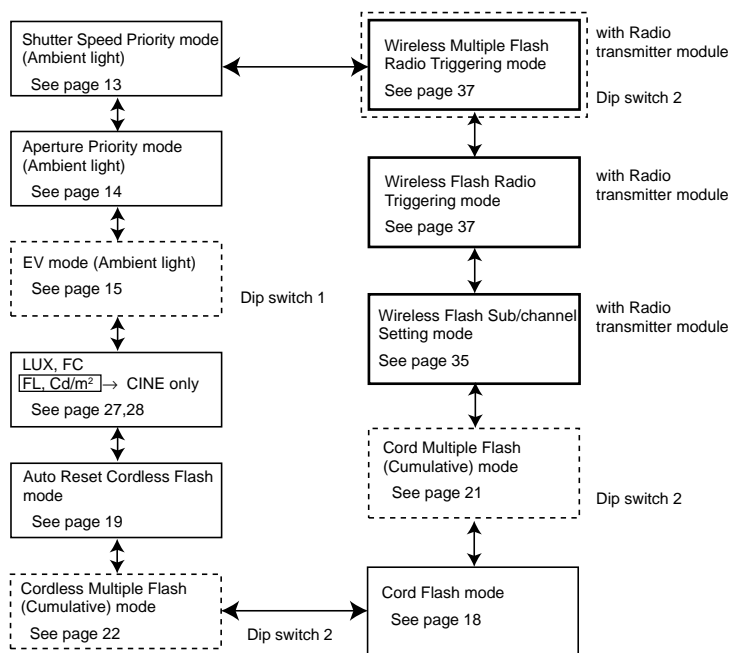
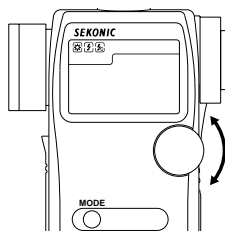
1. Hold down the Mode set button  and turn the Set/change dial  to select the desired mode. The mode switching sequence is shown in the chart below:



- Modes enclosed in dotted lines  can only be selected when the respective DIP switch is in ON position (see page 8).
- Modes enclosed in  lines can only be selected when Optional Radio Transmitter Module is installed.
- Each mode can be selected to display or not with custom setting. (See page 33)
- FC or LUX (Illuminance) can be displayed in incident light mode.
- FL or Cd/m<sup>2</sup> (Luminance) can be displayed in reflected light mode. (608 CINE only)

#### Reference:

- Ambient light is continuous light like natural light (sunlight), fluorescent lamps or tungsten lamps.
- Flash light is a brief, intense burst of light made by such as electronic flash units or flash bulbs.

### 3. Setting DIP Switches

1. Switches for setting modes that are used infrequently are housed in the Battery compartment of the meter. Select the mode you want prior to beginning measurements.
  2. The DIP switches can be set by sliding the DIP switch ⑱ for the mode you want to select in the ON position.
- \* **EV settings**  
When DIP switch 1 is turned on, EV exposure readings are possible. (ambient light)
  - \* **Multi settings**  
When DIP switch 2 is turned on, multiple flash cumulative mode is possible.
  - \* **Buzzer setting**  
When DIP switch 3 is on, the buzzer sounds when light from a flash is received in the cordless mode.
  - \* **CS setting (custom settings)**  
When DIP switch 4 is on, the mode changes to the custom setting mode, thereby enabling various settings (refer to P33).

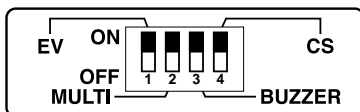

## 4. Basic Operation

---

### 4. When set for incident light

1. You can select extended or retracted lumisphere measuring positions by firmly rotating the lumisphere retracting ring (UP/DOWN) until it clicks into position.

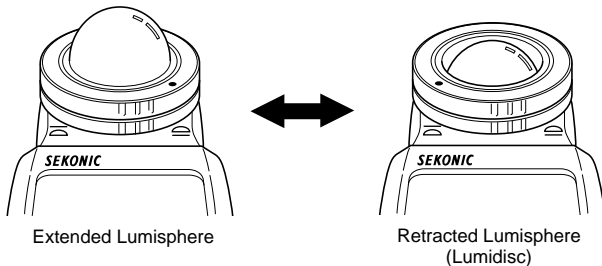

2. When the Lumisphere is extended. (3-D Light Measurement)  
This is used to photograph people, buildings, and other three dimensional objects. Measurements are basically made by the method of measuring with the lumisphere aimed in the camera direction (more precisely, in the direction of the lens axis) at the position of the subject.
3. When the Lumisphere is retracted (flat diffuser function)  
This is used to photograph manuscripts, paintings or other flat copy. It can also be used for measuring illumination levels (see page 27), or brightness difference (see page 25).

#### NOTE:

- If the device is used with the Lumisphere retracting ring in a middle position, distributed light quality will change, and suitable measurements cannot be made.
- Do not push the Lumisphere down manually. Always use the Lumisphere retracting ring.
- If the lumisphere becomes soiled, wipe it with a soft, dry cloth. Organic solutions (paint thinner, benzene, etc.) must not be used under any circumstances.

## 4. Basic Operation

### 5. When set for reflected light (spot metering)

1. This method measures the brightness (luminance) of the light reflected from the subject. It is useful for distant objects such as landscapes, when you cannot go to the position of the subject, or for metering subjects that generate light (neon signs, etc.), highly reflective surfaces or translucent subjects (stained glass, etc.).
2. The spot metering area can be selected by turning the Zoom Lens ring 26 while looking through the viewfinder from the camera position.
3. Take the measurement by aligning the circle inside the viewfinder with the subject area to be measured.
4. The black circle (A) in the finder indicates the measurement range. The light receiving angle is 1 degree with the telephoto setting of the zoom lens and 4 degrees with the wide angle.

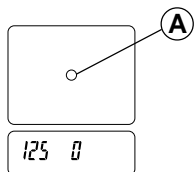
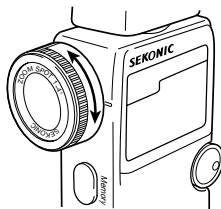

(Display in spot viewfinder)

#### < Diopter Adjustment >

Turn the eyepiece 24 and adjust the diopter so that the circle in the finder is clearly visible when you look into the finder.

#### < Step-Up Ring (Lens Hood)> (optional)

The step-up ring (30.5mm → 40.5mm), available as an optional accessory, makes it possible to mount step-up rings and filters. This simplifies the setting of exposure without the troublesome correction calculation of polarizing filters, etc.

The step-up ring can also be used as a hood to protect the zoom lens from scratching, soiling, etc.

#### < 2x Angle Converter > (optional)

Mounting the 2x angle converter to the objective lens unit enables zoom measurements at a light receiving angle of 2° - 8°.

## 4. Basic Operation

---

< Lumigrad > (optional) (Receiving Angle 54°)

1. Remove the Lumisphere  
The lumisphere unit is removed by holding both the upper and lower sections of Lumisphere retracting ring ① and turning it counterclockwise while pushing the Lock lever downward.

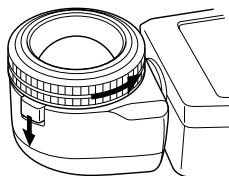

2. Mount the lumigrad  
To mount Lumigrad, align the mount/removal indicator on the Lumigrad with the  mark and then clockwise direction to secure it in place.

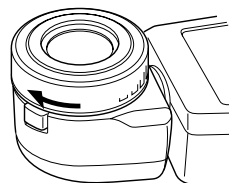

3. Take measurements by aiming the lumigrad precisely at the area of the subject to be measured from the position or direction of the camera.
4. Follow the same procedure to mount the lumisphere.

### CAUTION:

- Be sure to avoid touching the light receiving sensor when mounting or removing the lumisphere or lumigrad. In case of touching it, clean with soft dry cloth.



### 1. Measuring ambient light

In this measurement mode, we have the choice of shutter priority mode, aperture priority mode and EV mode. Hold down the Mode set button (10) and turn the Jog wheel (5) to select ambient measurement mode (8).

#### 1-1 Shutter Speed Priority mode

1. Hold down the Mode set button (10) and turn the Jog wheel to select Shutter Speed Priority mode (T).

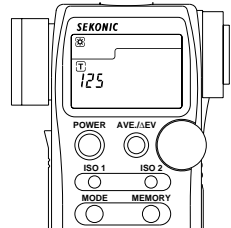

2. Turn the Jog wheel to set the desired shutter speed.

3. Press the Measuring button (15) to make a measurement. Release the Measuring button to complete the measurement. The measured value (aperture value) at that time will be displayed.

While pressing the Measuring button, the meter measures continuously until it is released.

#### NOTE:

- The LCD panel displays 1/10 stop only when either increments of shutter speed or aperture is set full stop with custom settings.

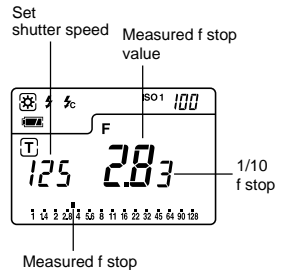

#### Reference:

- It is possible to switch between full, 1/2 and 1/3 shutter speeds with custom settings (see page 33).
- You can set shutter speeds from 30 minutes to 1/8000 seconds. After 1/8000 the shutter speeds of 1/200 and 1/400 can be set.
- After measurement, the F stop value corresponding to the shutter speed is displayed when the shutter speed is changed.
- The L-608 displays the measured aperture value in either full or half stop increments on the analog scale, while L-608 CINE displays it in either full or 1/3 stop increments.
- "E.u" (Exposure under) or "E.o" (Exposure over) appears when the combination of shutter speed and aperture is outside the display range. Changing the shutter speed or aperture with the Jog wheel will allow you to find a combination that is possible.
- If the "E.u" or "E.o" readout blinks, this indicates that the light level is beyond the measurement range of the light meter. Adjust lighting in this case.

## 5. Measurement

### 1-2 Aperture Priority mode

1. Hold down the Mode set button (10) and turn the Jog wheel to select aperture priority mode (F).
2. Turn the Jog wheel (5) to set the desired f stop value.

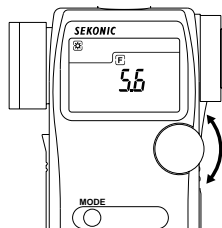

3. Press the Measuring button (15) to make a measurement. Release the Measuring button to complete the measurement. The measured value (shutter speed) at the time will be displayed.

While pressing the Measuring button, the meter measures continuously until it is released.

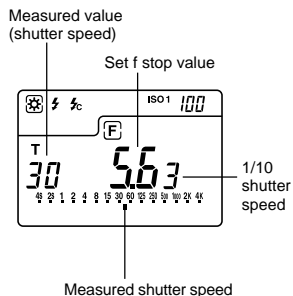

#### Reference:

- It is possible to switch between full, 1/2 or 1/3 F stop values with custom settings.
- You can set aperture from 0.5 to F161. Please note that in 1/3 stop increments F0.56 is displayed as  $\alpha 5$  and F0.63 is displayed as  $\alpha 6$ .
- The L-608 displays the measured aperture value in either full or half stop increments on the analog scale, while L-608 CINE displays it in either full or 1/3 stop increments.
- Readings outside the display range or beyond the measuring range are similar to the previous instruction (see page 13).
- After measurement, the shutter speed corresponding to the F stop is displayed when the F stop is changed.

## 5. Measurement

### 1-3 EV mode

Open the Battery compartment cover (16) and slide the EV DIP switch 1 (see page 9) to the ON position.

1. Hold down the Mode set button (10) and turn the Jog wheel (5) to select **EV** value mode.

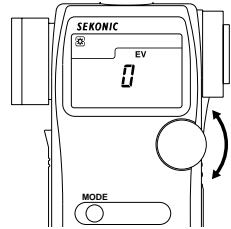

2. Press the Measuring button (15) to make a measurement. Release the Measuring button to complete the measurement. The measured value (EV value) at that time will be displayed.

At the same time, the shutter speed will be displayed in the digital display area, and the corresponding f stop will be displayed on the analog scale.

While pressing the measuring button, the meter measures continuously until it is released.

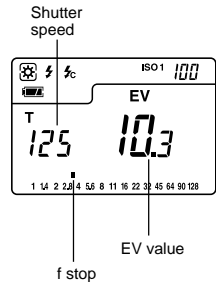



#### Reference:

- “E.u” (Exposure under) or “E.o” (Exposure over) on the T or F display area and “U” or “O” on the analog scale appears when the combination of shutter speed and aperture are outside the display range. Changing the shutter speed or aperture with the Jog wheel will allow you to find a combination that is possible.  
If the “E.u” or “E.o” readout and “U” or “O” on the analog scale blink, this indicates that the light level is beyond of the measurement range of the light meter. Adjust the lighting in this case.

## 5. Measurement

### 1-4 Cinematography

1. Hold down the Mode set button  and turn the Jog wheel  to select ambient light shutter speed priority mode .

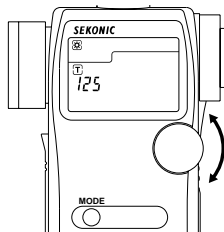

2. Turn the Jog wheel to select the Cine Speed for the camera that will be used.

Cine Speed are displayed after 1/8000, 1/200, 1/400 and the unit is in frames per second (f/s).

[L-608]

The following Cine Speeds will display: 2, 3, 4, 6, 8, 12, 16, 18, 24, 25, 30, 32, 36, 40, 48, 50, 60, 64, 72, 96, 120, 128, 150, 200, 240, 256, 300 and 360 f/s.

[L-608CINE]

The following Cine Speeds will display: 1, 2, 3, 4, 6, 8, 12, 16, 18, 24, 25, 30, 32, 36, 40, 48, 50, 60, 64, 72, 75, 90, 96, 100, 120, 125, 128, 150, 200, 240, 250, 256, 300, 360, 375, 500, 625, 750 and 1000 f/s.

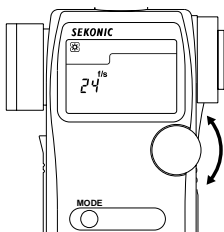

3. The shutter angle that these speeds are based on, is 180 degrees. For other angles make the following ISO film speed corrections (L-608 only).

Shutter angle	Amount of ISO film speed correction
160 degrees	-1/3
220 degrees	+1/3

## 5. Measurement

\* Example of correction value

-1/3: Decrease ISO film speed by 1/3 stop, example: ISO 80 -1/3 stop = ISO 64

+1/3: Increase ISO film speed by 1/3 stop, example: ISO 80 +1/3 stop = ISO 100

4. Press the Measuring button (15) to make a measurement. Release the Measuring button to complete the measurement. The measured value (f stop value) will be displayed.

While pressing the measuring button, the meter measures continuously until it is released.

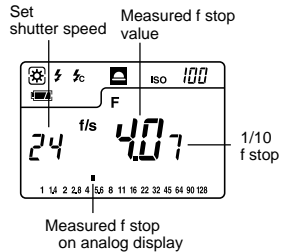

Reference:

- The L-608 displays the measured aperture value in either full or half stop increments on the analog scale, while L-608 CINE displays it in either full or 1/3 stop increments.
- Readings outside the display range or beyond the measuring range are similar to the previous instruction (see page 13).

5. Setting the shutter angle (608 CINE only).

It is possible to set the shutter angle by turning the Jog wheel while pressing mode set button (10) and ISO2 button (6) .

Note:

- Shutter angle: The angle can be set in the range of 5° - 270° (in 5° steps) as well as 144° and 172°.
- "Ang" is displayed continuously on the LCD display if the shutter angle is set to any value other than 180°.
- Press the mode set button and ISO2 button to confirm the shutter angle since it is not displayed.

Reference:

- This setting is only valid when the shutter speed is set to display cine speed (f/s) in the cine mode.

## 5. Measurement

### 2. Measuring flash light

This method of measurement can be done in the following modes; with cord, without cord, multiple flash with cord, multiple flash without cord and Wireless flash radio triggering mode (with optional radio transmitter module). When Measuring flash light, the shutter speed and F stop value (value combining ambient light and flash light: total amount of light) are displayed. The ambient light and flash light are each displayed as separate values together with the total amount of light on the analog scale. In addition, the ratio of flash light to the total amount of light is displayed at that time as a value in 10% steps. The flash reading is displayed as a blinking mark above the analog scale. (See page 32 for details)

#### 2-1 Cord Flash mode

Connect the meter to the flash with a synchronization cord. Be sure to replace Synchro terminal cap ⑳ after your measurement.

1. Connect the flash synchro cord to the Synchro terminal ⑧ on the exposure meter.

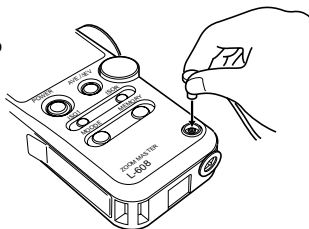

2. Hold down the Mode set button ⑩ and turn the Jog wheel ⑤ to select cord flash mode ⑥.
3. Turn the Jog wheel to set shutter speed. When setting shutter speed, first check the settings to confirm that they correspond to the settings on the camera.

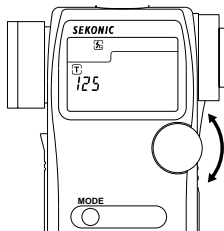

4. Press the Measuring button ⑮ to trigger the flash. The measured value (f stop value) will be displayed.

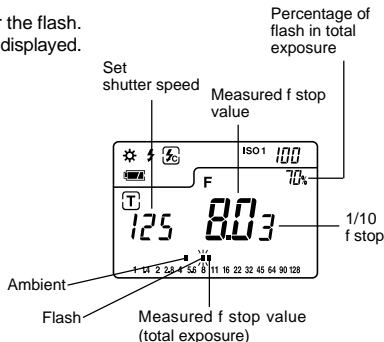

### CAUTION:

- There is danger of electric shock if the meter is handled with wet hands, during rain, in areas splashed by water or where there is a lot of moisture, if you use cord synchronized flash.
- Under such conditions, it is recommended that you use the meter in the cordless flash mode or Wireless flash radio triggering mode, and keep the Synchro terminal cap in place.

### NOTE:



- The electronic flash unit may trigger when you connect the Synchro cord or operate the POWER Switch.
- Triggering voltage is 2.0 to 400 volts. For below 2.0V, trigger flash with the cordless flash mode or wireless flash radio triggering mode, not synchro cord.

### Reference:

- It is possible to switch the shutter speed between full, 1/2 and 1/3 stops by custom setting of the DIP switch 4 (refer to P33).
- The shutter speed can be set from 30 minutes to 1/1000 of a second. After 1/1000 sec, the meter can be set at the following intermediate speeds: 1/75, 1/80, 1/90, 1/100, 1/200, or 1/400.
- If the film speed is changed after the measurement is taken, the new converted measured value (f stop value) will be displayed.
- After measurement, the F stop value corresponding to the shutter speed is displayed when the shutter speed is changed.
- "E.u" (Exposure under) or "E.o" (Exposure over) appears when the combination of shutter speed and aperture are outside the display range. Change the shutter speed with the Jog wheel and take measurements again.
- If the "E.u" or "E.o" readout blinks, this indicates that the light level is beyond the measurement range of the light meter.

### 2-2 Auto-reset cordless flash mode

Measurements are made by the meter receiving the light from the flash. This measurement mode is used when the Synchro cord will not reach because of the distance between the flash and meter or when use of the Synchro cord is inconvenient.

1. Hold down the Mode set button  and turn the Jog wheel  to set Auto-reset Cordless Flash mode .
2. Turn the Jog wheel to set shutter speed. When setting shutter speed, first check the settings to confirm that they correspond to the settings available on the camera.

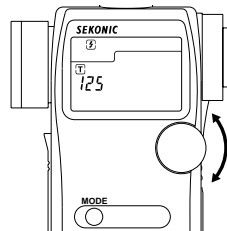

## 5. Measurement

- When the Measuring button  $\text{M}$  is pressed, the mode mark  $\text{F}$  will blink and the meter is ready to measure. The ready to measure mode will continue for approximately 90 seconds. During this time, trigger the flash to make a measurement.

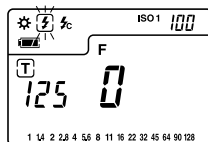

- If the 90 second period is exceeded and the blinking mark stops, press the Measuring button again to return to ready to measure.

- When the light from the flash is received, the measured value (f stop) is displayed. Even after measurement, the mode mark  $\text{F}$  continues to blink and the meter is in ready state and a new measurement can be made. (Auto-reset function)

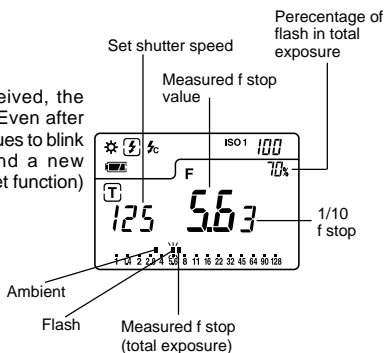

### NOTES:

- When firing a flash, if the flash brightness is low compared to the ambient light, the meter may fail to detect the light. In this case, make measurements using the cord flash mode.
- Rapid start fluorescent lamps and special lighting are sometimes mistaken for flash, and accidentally measured. In this case, make measurements using the cord flash mode.
- The meter's tripod socket permits mounting it to a tripod or light stand and placing it strategically when using cordless flash mode.

### Reference:

- After measurement, the F stop value corresponding to the shutter speed is displayed when the shutter speed is changed.
- Setting the shutter speed is similar to the previous instruction. (see page 18) of "Cord flash mode" of section 2-1.
- A new converted value is displayed when the film speed is changed after taking the measurement.
- Readings outside the display range or beyond the measuring range are similar to the previous instruction. (see page 19) of "Cord Flash mode" of section 2-1.



## 5. Measurement

### 2-3 Cord multiple flash (cumulative) mode

These measurements are used when the light generated by the flash is inadequate for proper exposure. The repeated flash pops can be accumulated until the desired aperture is displayed. The cumulative number is infinite. Only one digit is displayed if the cumulative number is ten or more. Display returns 0 (0=10, 1=11, 2=12, etc.)

1. Slide DIP switch 2 to MULTI (see page 9) to the ON position.  
Hold down the Mode set button **10** and turn the Jog wheel **5** to select cord multiple flash (cumulative) mode **2** **MLT**.

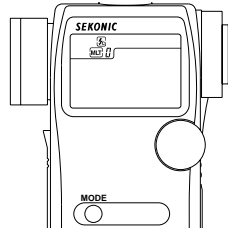

2. Turn the Jog wheel **5** to set shutter speed. When setting shutter speed, first check the settings to confirm that they correspond to the settings available on the camera.
3. Connect the Flash synchro cord to the meter's synchro terminal **8**.

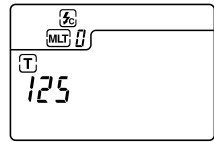

4. Press the Measuring button **15** to trigger a flash. The measured f stop value at that time will be displayed. Each time this is repeated, the accumulated f stop value and the number of cumulative flashes is displayed.

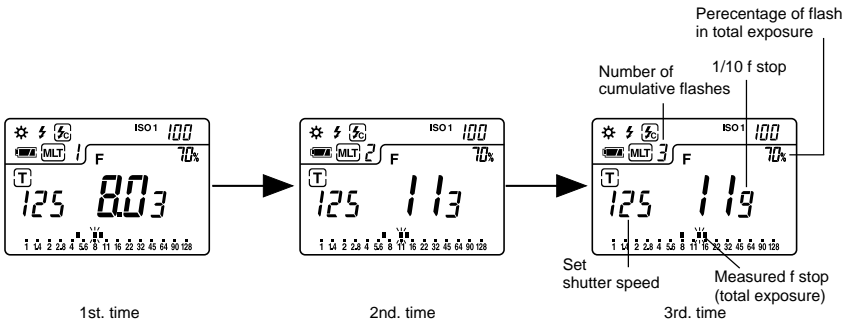

5. To clear the cumulative value, press M. CLEAR button **25** or switch to another mode by turning the Jog wheel while pressing the mode set button.

## 5. Measurement

### CAUTION:

- There is danger of electric shock if the meter is handled with wet hands, during rain, in areas splashed by water or where there is a lot of moisture. Under such conditions, it is recommended that you use the meter in the cordless flash mode, or wireless flash radio triggering mode and keep the Synchro terminal cap in place.

### NOTE:



- The flash unit may flash when you connect the synchro cord or operate the POWER switch.
- When firing a flash to take measurements, check the camera's synchronizing range and set the proper shutter speed.
- For flash units with low electric trigger voltage, the flash may not fire. In this case, make measurements in cordless flash mode or wireless flash radio triggering mode.

### Reference:

- Setting the shutter speed is similar to the previous instruction (see page 18).
- Readings outside the display range or beyond the measuring range, are similar to the previous instruction (see page 19) of "Cord flash mode" of section 2-1.
- If the film speed is changed after the measurement is taken, the new converted measured value (f stop value) will be displayed.

### 2-4 Cordless multiple flash (cumulative) mode

These measurements are used when the light generated by the flash is inadequate for proper exposure. The repeated flash pops can be accumulated until the desired aperture is displayed. The cumulative number is infinite. Only one digit is displayed if the cumulative number is ten or more. Display returns 0 (0=10, 1=11, 2=12 etc.)

1. Slide DIP switch 2 to MULTI (see page 9) to the ON position.
2. Hold down the Mode set button  and turn the Jog wheel  to select flash measurement cordless multiple flash (cumulative) mode . Turn the Jog wheel to set shutter speed. When setting shutter speed, first check the settings to confirm that they correspond to the settings available on the camera.

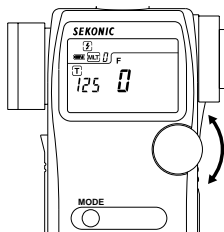

## 5. Measurement

- When the light from the flash is received, the measured value (f stop) is displayed. Each time this is repeated, the accumulated value for the aperture and the number of cumulative flashes is displayed.

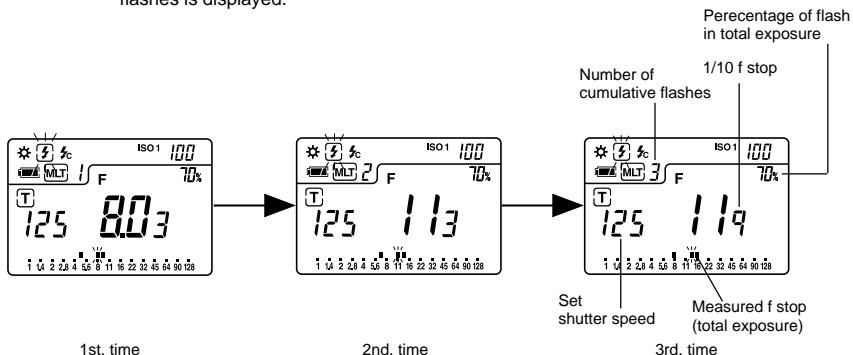

- The ready to measure mode will be displayed for approximately 90 seconds. If the 90 second period is exceeded and the blinking mark stops, press the Measuring button  $\text{15}$  again. The measured value (f stop) of the previous time reverts to 0 and the meter is in ready to measure mode.

### NOTE:

- When firing a flash, if the flash brightness is 9 EV lower than the ambient light, the meter may fail to detect the light. In this case, make measurements using the flash with cord flash mode.
- Rapid start fluorescent lamps and special lighting are sometimes mistaken for flash, and accidentally measured. In this case, make measurements using the flash with cord flash mode.

### Reference:

- Setting the shutter speed is similar to the previous instruction (see page 18).
- Readings outside the display range or beyond the measuring range are similar to the previous instruction. (See page 13)
- See page 35 for further details of Wireless flash radio triggering system.

## 6. Advanced Functions

### 1. Memory function

This meter can store up to nine measured values in memory for incident light and reflected light independently. This feature can be used in the following modes;

Ambient light : shutter speed priority, aperture priority (L-608 only) or EV mode.

Electronic Flash light : cord, cordless or wireless flash radio triggering mode.

1. Press the Measuring button (15) and take a measurement.

2. Press the Memory button (7) and store the measured value in memory.

The number of values in memory is displayed on the LCD. The memorized value is displayed on the analog scale. By repeating this operation, up to nine values can be stored in memory.

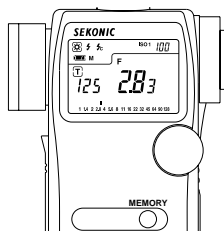

3. To clear the memory, press the memory clear button (25) or switch to another measurement mode.

#### 4. Memory Recall

When the Jog wheel (5) is rotated while both Memory button (7) and the Mode set button (10) are held down together, the measured value stored in the memory is displayed along with the memory number. When any previous stored value is recalled with the exception of the last stored value, the "M" and number will blink.

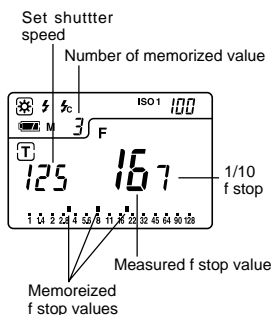

#### NOTE:

- The memory function cannot be used in "Multiple flash cumulative mode."
- Measured values for ten times and over will be displayed but cannot be stored in memory.

## 6. Advanced Functions

### 2. Averaging function

This function displays the average of up to nine of the values in memory.

1. Press the Measuring button (5) and take a measurement.
2. Press the Memory button (7) and store the measured value in memory.
3. When the Ave/ Δ EV button (4) is pressed, an average value for up to nine measurements will be displayed on the LCD. The value in memory and the average values are displayed on the analog scale. An "A" appears in LCD to indicate this is an average.
4. The average mode can be canceled by pressing the Ave/ Δ EV button.

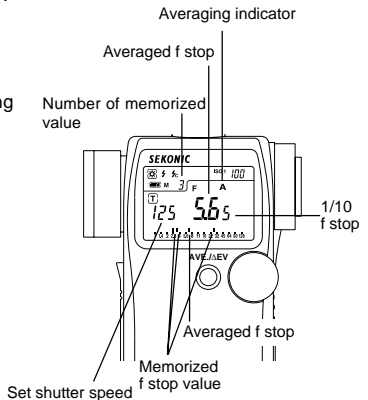
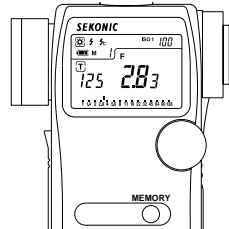

### 3. Brightness difference function

This function is useful for evaluating studio lighting and checking the evenness of the lighting set-up across the subject area.

Take a measured value at a certain point as a standard value. The difference between the standard value and a new measured value is displayed as EV and the measurements on the analog scale.

Example of adjusting lights using brightness measurement with shutter speed priority mode (incident light).

1. Turn the Lumisphere retracting ring (1) to lower it to the  mark position.



## 6. Advanced Functions

- Turn any secondary light source off. Point the Lumisphere toward the main light source, from the position of the subject and take a measurement. Press the Memory button **7** and store the value in memory.
- Press the Average/  $\Delta$  EV button **4** and display the "A" mark on the LCD indicating a standard value.

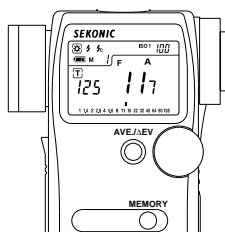

- Turn the main lighting off. Now, point the Lumisphere toward the secondary light source. While the Measuring button **15** is depressed and held down, the indicated difference between the main and auxiliary light sources is displayed in EV values. At the same time, the standard value and a new measured value are displayed on the analog scale.

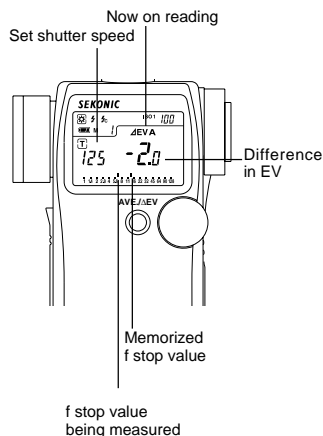

EV difference of $\Delta$ EV value	Contrast ratio
1	2 : 1
1.5	3 : 1
2	4 : 1
3	8 : 1
4	16 : 1

- Standard value can be cleared by pressing the Memory clear button, or Ave./  $\Delta$  EV button.

### Reference:

- To determine exposure after adjusting lights, turn both main and secondary light sources on, raise the Lumisphere to the  $\triangle$  mark position, then take a reading along the camera light axis in incident light.
- This function can also be used for reflected light.

## 6. Advanced Functions

### 4. How to use an incident illuminance (LUX or FC) meter

1. Turn the Lumisphere retracting ring ① to lower it to the  mark position.
2. Make sure that any compensation (see page 29) is canceled.
3. Set the meter to LUX or FC mode for incident light with custom setting (see page 33).
4. Place meter parallel to the subject and take a measurement.

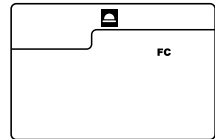
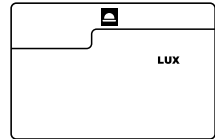
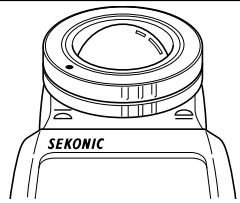

#### Reference:

- Setting the meter to EV mode (DIP switch 1) and ISO 100, the measured EV can be converted to find the brightness level with the below conversion table.

#### \* EV value → Lux conversion table

EV \ Decimal places	0	0.5	EV \ Decimal places	0	0.5
-2	0.63	0.88	9		1800
-1	1.3	1.8	10		3600
0	2.5	3.5	11		7200
1	5.0	7.1	12		14000
2	10	14	13		29000
3	20	28	14		58000
4	40	57	15		120000
5	80	110	16		230000
6	160	230	17		460000
7	320	450	18		930000
8	640	910	19		1900000

#### \* EV value → Foot candle (FC) conversion table

EV \ Decimal places	0	0.5	EV \ Decimal places	0	0.5
-2	0.06	0.08	9	120	170
-1	0.12	0.16	10	240	340
0	0.23	0.33	11	480	670
1	0.46	0.66	12	950	1300
2	0.93	1.3	13	1900	2700
3	1.9	2.6	14	3800	5400
4	3.7	5.3	15	7600	11000
5	7.4	11	16	15000	22000
6	15	21	17	30000	43000
7	30	42	18	61000	86000
8	59	84	19	120000	170000

## 6. Advanced Functions

---

### 5. How to use a reflected luminance (cd/m<sup>2</sup> or FL) meter

1. Make sure that any compensation (see page 29) is canceled.
2. Set the meter to Cd/m<sup>2</sup> or Foot-lambert mode for reflected light with custom setting (see page 33).
3. Set meter to spot reading for reflected light.  
Take the measurement by looking through the finder and aligning so the subject that will be measured is inside the circle.

#### Reference:

- Setting the meter to EV mode (DIP switch 1) and ISO 100, the measured EV can be converted to find the brightness level with the below conversion table.

\* EV value → cd/m<sup>2</sup> conversion table

EV \ Decimal places	0	0.5	EV \ Decimal places	0	0.5
3	1	1.4	12	510	720
4	2	2.8	13	1000	1400
5	4	6	14	2000	2900
6	8	11	15	4100	5800
7	16	23	16	8200	12000
8	32	45	17	16000	23000
9	64	91	18	33000	46000
10	130	180	19	66000	93000
11	260	360			

\* EV value → Foot-lambert (FL) conversion table

EV \ Decimal places	0	0.5	EV \ Decimal places	0	0.5
3	0.09	0.13	12	48	67
4	0.19	0.26	13	95	140
5	0.37	0.53	14	190	270
6	0.74	1.1	15	380	540
7	1.5	2.1	16	760	1100
8	3.0	4.2	17	1500	2200
9	5.9	8.4	18	3000	4300
10	12	17	19	6100	8600
11	24	34			



## 6. Advanced Functions

### 6. How to use the Exposure compensation function

Exposure compensation can be made in precise 1/10 step increments in a +/- 9.9 EV range. Exposure compensation may be desired when requiring compensation for filters, bellows extension, etc.

- Making a plus compensation will result in underexposing when taking a photograph. Hold the ISO1 button (1) and the ISO 2 button (6) and turn the Jog wheel (5) counter clockwise. The  $\frac{+}{1.1}$  will appear on the upper right part of the LCD. The compensation will change in +0.1 EV steps up to +9.9.

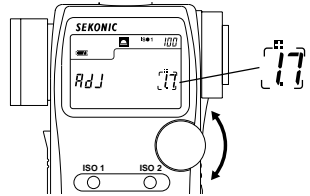

- Making a minus compensation will result in overexposing when taking a photograph. Hold the ISO1 button and the ISO 2 button and turn the Jog wheel clockwise. The  $\frac{-}{1.1}$  will appear on the upper right part of the LCD. The compensation will change in -0.1 EV steps up to -9.9.

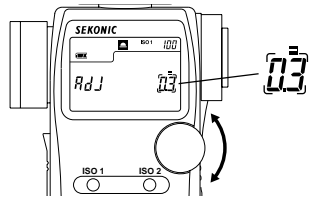

#### NOTE:

- Make compensation after a sufficient number of tests in actual photographic conditions have been made to suit your needs.
- Compensation effects every mode of the meter.  
If recalibration has been made for specific purpose do not forget to return to original zero settings.

#### Reference:

- When compensation is activate, a plus (+) or minus (-) sign as well as the amount of compensation is displayed continuously on the LCD display.
- You can set custom settings so that a plus (+) or minus (-) sign as well as the amount of compensation doesn't appear on the LCD. (See page 33)

## 6. Advanced Functions

---

### 7. How to use Calibration compensation function

Calibration compensation can be made in precise 1/10 step increments in a +/- 1.0 EV. It may be desired to match specific requirements, calibration to other meters, etc.

1. Set the measurement mode (incident light, reflected light) for the desired compensation. You can make calibration compensation independently for both incident, and reflected light. It is not possible to switch between measurement modes if the setting is not completed.
2. To enter the calibration setting of the meter it must first be turned off. Press the power button on while holding down the ISO1 and ISO2 buttons simultaneously ; the screen will display CAL 0.0 (for calibration).
3. The calibration setting can be changed by rotating the Jog wheel while pressing and holding down the ISO 1 and ISO 2 buttons simultaneously. A range of +/- 1.0 EV in 1/10 step increments is possible for calibration.

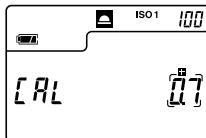

**NOTE:**

- When making calibration compensation, be sure that it satisfies your needs based on the results of adequate test film.
- While incident and reflected light can be set independently, be aware that both ambient light and flash exposure are corrected uniformly.

**Reference:**

- The calibration setting is not displayed on the main screen once it is set.

## 8. Filter compensation

## Filter compensation (1)

It is possible to compensate for filter factory within a range of  $\pm 5.0$  EV in 1/10 steps. The measurement corresponding to the set compensation is displayed while pressing ISO2 button ⑥.

1. Select setting number 1 and item number 1 in the custom setting mode (refer to P33).
2. Set the desired compensation by turning the Jog wheel ⑤ while pressing ISO2 button ⑥.

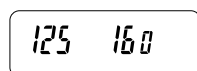
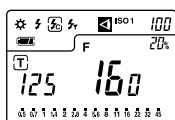
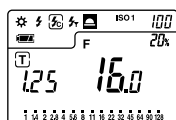

Display in finder

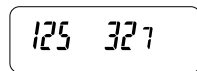
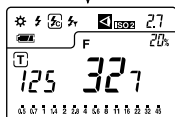
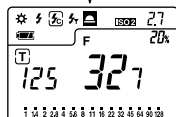

Display in finder

L-608

L-608CINE

Filter factor number compensation (2) (608 CINE only)

1. When using in cine industry, it is possible to set 7 different frequently used types of filters.
2. Select setting number 1 and item number 2 in the custom setting mode.
3. The symbol of the desired filter from among the 7 types can be selected by turning the Jog wheel ⑤ while pressing ISO2 button ⑥.
4. After filter compensation, the filter symbol and compensated F value or EV value are displayed while pressing ISO2 button.

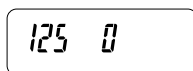
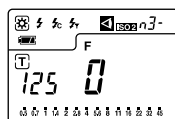

Display in finder

## Filters, LCD Display and Corrected Value

Filter Factor No.	85	NDO.3	NDO.6	NDO.9	85N3	85N6	85N9
LCD display	85-	n3-	n6-	n9-	A3-	A6-	A9-
Compensated value (EV)	-0.7	-1	-2	-3	-1.7	-2.7	-3.7

(Filter factor numbers are Kodak Wratten filter numbers.)

## 6. Advanced Functions

### 9. Flash analyzing function

When measuring flash light, the shutter speed and F stop value (value combining ambient light and flash light: total amount of light) are displayed in the liquid crystal display and the ambient light and flash light are each displayed as separate values together with the total amount of light on the analog scale. In addition, the ratio of flash light to the total amount of light is displayed at that time as a value in 10% steps. It is possible to use this value for adjustments, for example, when photographing with a flash in a room illuminated by tungsten light, to emphasize or weaken the tungsten (ambient) light element (enhancing the flash light of the photograph) to match the photographer's intentions.

#### < Example >

If, under certain conditions, the flash light component is 60% and the tungsten output component is 40%, the display will be as indicated at the right. Flash reading on the analog scale will blink.

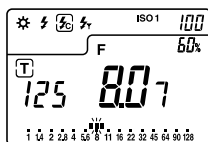

1. To emphasize the tungsten (ambient) light (to imbue the atmosphere with orange-colored tones)  
To increase the ratio of tungsten light, use the Jog wheel (5) to change the shutter speed to a slower setting.

It is apparent that the flash light component is now 20%. The analog scale also shows the tungsten output component to be about 2.5 stop higher than the flash light component.

As a result, images on the film are expressed with orange tones that give life to the effect of the tungsten light.

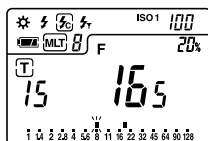

2. To reduce the effect of tungsten light (to realize a more natural atmosphere)

To decrease the ratio of tungsten light, use the Jog wheel to change the shutter speed to a faster setting. It is apparent that the flash light component is now 80%. The analog scale also shows the flash light component to be about 1.5 stop higher than the ambient light component.

As a result, the images on the film are expressed in natural color tones.

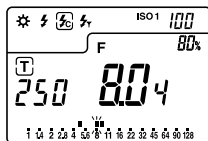

#### Reference:

- Slower shutter speeds allow more available light to reach the film, and faster shutter speeds allow less available light to reach the film.
- The settings above are made by adjusting the tungsten (ambient) light by the shutter speed. It is also possible to modify the ratio by adjusting the flash light (when changing the distance between the flash and the subject or when changing the amount of light of the flash). When using this method, re-measure each time the flash light is adjusted.

## 6. Advanced Functions

### 10. Custom setting function

It is possible to set the required functions in advance.

CUSTOM SETTING LIST				Item			
No.	Model	Lighting	Custom Setting name	Item			
				0	1	2	3
1	608	Ambient & Flash	ISO 2 setting	Film Sensitivity 1/3 step	Filter compensation (1) 0.1EV step (±5EV)	—	—
	CINE			Film Sensitivity 1/3 step	Filter compensation (1) 0.1EV step (±5EV)	Filter compensation (2) 7 Filter factor numbers	—
2	608&CINE	Ambient & Flash	Exposure Compensation Display setting	Always display	Not display	—	—
3 *1	608&CINE	Ambient & Flash	Increments of Shutter Speed	full stop	1/3 stop	1/2 stop	—
4 *1	608&CINE	Ambient & Flash	Increments of Aperture	full stop	1/3 stop	1/2 stop	—
5	608&CINE	Ambient	T priority mode	Available	Not Available	—	—
6	608&CINE	Ambient	F priority mode	Available	Not Available	—	—
7	608&CINE	Flash	Code-in mode	Available	Not Available	—	—
8	608&CINE	Flash	Code-less mode	Available	Not Available	—	—
9	608&CINE	Flash	Flash Analyzing function	Available	Not Available	—	—
10 *2	608&CINE	Ambient	Illuminance or Luminance (CINE only) display	Compound + Individual	Compound	Individual	—
11	608&CINE	Ambient	Illuminance measurement in Incident mode	Not Available	LUX	FC	LUX, FC
12	CINE	Ambient	Luminance measurement in Reflected mode	Not Available	cd/m <sup>2</sup>	FL	cd/m <sup>2</sup> , FL

## 6. Advanced Functions

\*1 1/10 stop fractions are displayed in below combinations (○)

T priority

	T 1 stop	T 1/3 stop	T 1/2 stop
F1 stop	○	○	○
F1/3 stop	-	-	-
F 1/2 stop	-	-	-

F priority

	T 1 stop	T 1/3 stop	T 1/2 stop
F1 stop	○	-	-
F1/3 stop	○	-	-
F 1/2 stop	○	-	-

\*2 Individual: LUX, FC, cd/m<sup>2</sup> or FL

Compound: LUX+T+F, FC+T+F, cd/m<sup>2</sup>+T+F or FL+T+F (combination)

1. To enter the custom setting mode, the meter must first be turned off. Set DIP switch 4 to on position and turn the power on. It is not possible to enter the custom setting mode if DIP switch 4 is set to on after turning on the power.

2. In the custom setting mode, 'CS' (custom setting) is displayed in the ISO display area, a setting number between 01-11 (608) or 01-12 (608 CINE) is displayed in the shutter speed display area and item number 0, 1, 2 or 3 is displayed in the aperture display area.

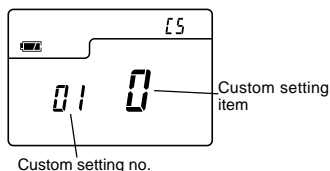

3. Turn the Jog wheel (5) and select the desired setting number and the custom setting name.

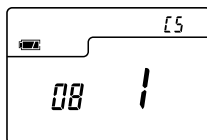

4. The item number will change each time the Mode set button (10) is pressed.

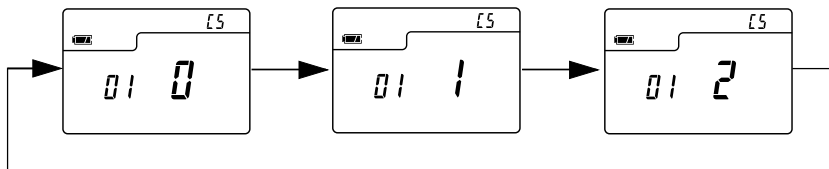

## 6. Advanced Functions

---

5. Pressing the memory clear button  in the custom setting mode will reset all settings to default (No.0).
6. After completing the custom setting, terminate the custom setting mode by setting DIP switch 4 to off position. This operation will also automatically turn off the power. Since the power cannot be turned off by pressing the power button while in the custom setting mode, turn off the power by setting DIP switch 4 to off.

## 6. Advanced Functions

### 11. Wireless Flash radio triggering

With the radio transmitter module plugged into the meters radio socket and a receiver (RR-4 or RR-32 sold separately, or PocketWizard® products) connected to one or more electronic flash units, the meter provides a convenient system that enables one person working alone to measure flash output without the need of a sync cord. Pressing the Measuring button simultaneously triggers the flash and measures the light.

The L-608/608 CINE has 32 triggering channels when the radio triggering module (RT-32) is plugged into the radio socket. Channels 1-16 provide single triggering, while channels 17-32 offer selective quad-triggering capability. Selecting one of channels (17-32) provides control of up to four additional sub-channels (A, B, C and D). Selecting or deselecting of zone lighting is possible with sub-channels. In order to trigger flash units set for sub-channels, the electronic flash unit must be connected to the RR-32 receiver or PicketWizard MAX or MultiMax. With the RR-4 receiver or PocketWizard Plus triggering channels 1-4 can be selected.

< Example with optional 32 channels receiver >

1. Open battery compartment cover (16), remove connector cover and set the RT-32 radio transmitter module (optional) by aligning the connector with the pins.

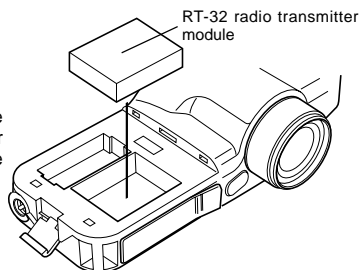

### ⚠ CAUTION

- To prevent damage due to static electricity, release static electricity stored in your body by touching a metal object nearby (door knob, aluminum window frame, etc.) before touching the radio transmitter module.

2. Switch to the Wireless flash radio triggering setting mode by using Jog wheel (5) while pressing mode set button (10) (17).

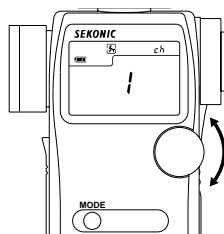



## 6. Advanced Functions

- The set channel number will blink on and off at this time. Turn the Jog wheel to set the channel setting.
- In the Setting mode, "ch" appears on the ISO display area. At the same time, channel numbers (1 to 16 and 17 to 32) appear on the F display area. When the channel number is 17 to 32, sub-channel (A, b, c and d) settings are displayed on the T indicator. In the absence of settings, "-" appears in the figures.

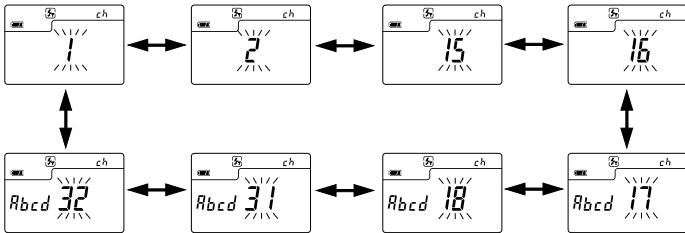

- In sub-channel settings, after the channel is set to 17 to 32, the mode button is pressed. Following this, the 4th figure on the T display area blinks to indicate that settings may be made. Every time the mode button is pressed, the blinking settings shifts from sub-channel No. : 4th figure → 3rd figure → 2nd figure → 1st figure → channel No., while permitting settings for each sub-channel. As the Jog wheel is rotated in this state, setting ("A, b, c and d" displayed) and resetting ("-" displayed) alternate. During this process, the indicator continues to blink to indicate the channel being set.

→ Set by manipulating the mode set button.  
 ↔ Set by manipulating the Jog wheel.

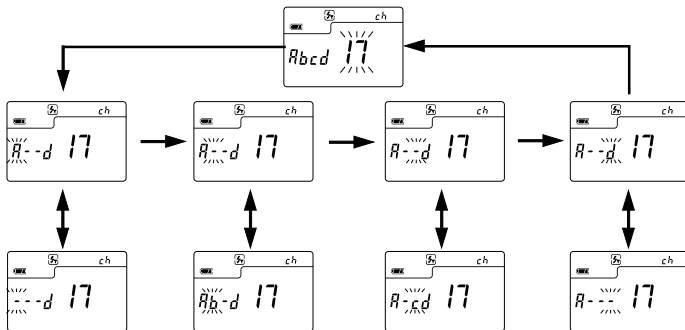

### ⚠ CAUTION

- When using quad channels 17-32, it is not possible to terminate this mode unless a sub-channel has been set (a, b, c or d is displayed).

## 6. Advanced Functions

---

6. Upon setting completion, the Wireless flash radio triggering mode or Wireless multiple flash radio triggering mode is selected using the Jog wheel while the Mode set button is pressed. For other settings of the measurement, see page 16.
7. Confirm that the meter and the radio receiver are set to the same channel number. The flash unit will fire when the measurement button of the meter is pressed and measurements can be made at the same time.

### Reference:

- Refer to the receiver instruction manual for the receiver operating method.
- Maximum controllable distance of the radio flash trigger system differs depending on the placement of the device, direction and other factors.
  1. Confirm the direct visible range between the transmitter and receiver.
  2. Place the meter and receiver away from large metal objects, concrete, objects with large moisture content (both people and trees fall into the category) and so forth.
  3. Secure the radio receiver in place by using Velcro tape or mounting 1/4-20 thread. Be sure that the entire length of the receiver antenna is higher than the flash pack at this time. Avoid contact between the receiver antenna and metal objects at all times.
  4. Depending on the location, there may be cases when the receiver is incapable of receiving any radio signals whatsoever.

There are various possible reasons for this such as radio signals reflected from nearby objects. This can generally be resolved by shifting the device slightly in one direction or another.

In addition, confirm that the device is not placed behind objects that readily absorb or deflect radio signals such as concrete, metal, low hills, etc.

### NOTE:

- The radio flash system may be used only in countries where a permit for the control frequency has been issued by the government office in charge.

## 7. Accessories

---

### Mini Light Receptor (Sold separately)

- Incident light receiving unit with a compact 12mm diameter light receiving surface.
- For measuring narrow areas used for photographing small subjects or copy work.

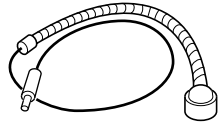

### Synchro cord (Sold separately)

- This is a five-meter long cord with three plugs. An exposure meter, a camera, and a flash can all be connected at the same time. This is convenient when measurements are made, because it is not necessary to plug and unplug the synchro cord.

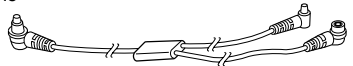

### 18% Gray Card (Sold separately)

- 18% gray card with cover (110mm x 102mm, 4 1/4" x 3 1/2"), folds to 2 3/4" x 4 3/4", and fits in a shirt pocket.
- It provides accurate exposures regardless of reflected ratio of the subject and surroundings.

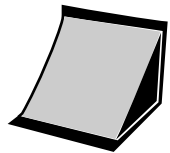

## 7. Accessories

---

Wireless flash radio triggering system (Sold separately)

- Combining radio transmitter module (RT-32) with radio receiver (RR-32 or RR-4) enables measurements by triggering the flash from the exposure meter.

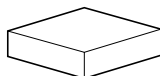

Radio transmitter module  
(RT-32, 32 channels)



Radio wave receiver  
(RR-32, 32 channels)



Radio wave receiver  
(RR-4, 4 channels)

Reference:

- RT-32 transmitter module, RR-4 and RR-32 receivers are compatible with Pocket Wizard® products from LPA Design.
- Light receiving angle 54° (Lumigrad) (Sold separately)  
This method measures the brightness (luminance) of the light reflected from the subject. It is useful for distant objects such as landscapes, when you cannot go to the position of the subject, or for metering subjects that generate light (neon signs, etc.), highly reflective surfaces or translucent subjects (stained glass, etc.).
- Step-Up Ring (30.5mm → 40.5mm) (Sold separately)  
The step-up ring, available as an optional accessory, makes it possible to mount step rings and filters of other manufacturers. This simplifies the setting of exposure without the troublesome correction calculation of PL filters, etc. The step-up ring can also be used as a hood to protect lenses from scratching, soiling, etc.
- 2x Angle Converter (optional) (Sold separately)  
Mounting the 2x angle converter to the objective lens unit enables zoom measurements at a light receiving angle of 2°-8°.

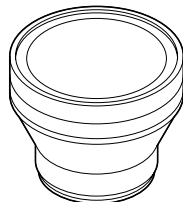
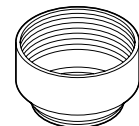
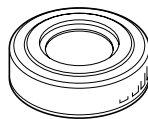

## 8. Technical Data

· Type	: Digital exposure meter for ambient and flash light
· Light receiving method	: Incident light and reflected light
· Light Receptors	
Incident light	: Convertible to flat diffuser (Lumisphere in down position)
Reflected light	: 1° to 4° element Zoom (display in finder) Metering distance 1m ~ ∞
· Light receptor element	: 2-Silicon photo diodes (incident and reflected)
· Metering modes	
Ambient light	: Aperture priority metering Shutter priority metering EV metering Simple illumination measurement (lux, foot-candle) Simple brightness measurement (608 Cine only) (foot-lambert, cd/m <sup>2</sup> )
Flash	: With synchro cord (cumulative, non-cumulative) Without synchro cord (cumulative, non-cumulative) Measurement using the optional wireless flash radio triggering system (cumulative, non-cumulative)
· Measuring Range (ISO 100)	
Ambient light	
Incident light	: EV-2 to EV 22.9
Reflected light	: EV 3 to EV 24.4 (with 1° ~ 4° zoom spot viewfinder) EV-2 to EV 22.9 (with optional 54° Lumigrid)
Flash	
Incident light	: f0.5 to f128.9 (approx. f175)
Reflected light	: f5.6 to f128.9 (approx. f175) (with 1° ~ 4° zoom spot viewfinder) f0.5 to f128.9 (approx.f175) (with optional 54° Lumigrid)
Illumination	: 0.63 - 190,000 lux (2 significant digits) 0.12 - 180,000 foot-candle (2 significant digits)
Brightness (608 Cine only)	: 1 - 190,000 cd/m <sup>2</sup> (2 significant digits) 0.3 - 190,000 foot-lambert (2 significant digits)
· Repeat Accuracy	: +/- 0.1 EV or less
· Calibration Constant	
Incident light metering	: Lumisphere C = 340 Flat diffuser C = 250
Reflected light metering	: K = 12.5
· Display Range	
Film speed	: ISO 3 to 8000 (in 1/3 steps)
Shutter Speeds	
Ambient light	: 30 minutes to 1/8000 seconds(in 1, 1/2 or 1/3 stop)also 1/200, 1/400 Cine speeds- 2, 3, 4, 6, 8, 12, 16, 18, 24, 25, 30, 32, 36, 40, 48, 50, 60, 64, 72, 96, 120, 128, 150, 200, 240, 256, 300, 360 frames per second (at a 180 degree shutter angle) (608 Cine addition) 1, 75, 90, 100, 125, 250, 375, 500, 625, 750, 1000
Flash	: 30 minutes to 1/1000 second (in 1, 1/2 or 1/3 stop),also 1/75, 1/80, 1/ 90, 1/100, 1/200, 1/400

## 8. Technical Data

---

- Aperture : f/0.5 to f/161 (in 1, 1/2 or 1/3 stop)  
f/0.5 to f/161 (in 1, 1/2 or 1/3 stop) (608 CINE)
- EV : EV -9.9 to EV 41.6 (in 1/10 stop)
- Analog scale : F1.0 - F128 (in 1/2 stop), T4.0 seconds - 1/4000 seconds (in 1/2 stop)(608)  
F0.5 - F45 (in 1/3 stop) (608 CINE)
- Shutter angle (608 Cine only)  
: 5° ~ 270° (in 5° stop), others: 144°, 172°
- Filter compensation : +/- 5.0 EV (in 1/10 stop)
- Filter factor numbers (608 Cine only)  
: 85-, n3-, n6-, n9-, A3-, A6-, A9-
- Other features :
- All-weather feature : JIS standard water resistance class 4, splash-proof type
  - Memory function : 9 readings
  - Memory clear recall function
  - Multiple Flash function : Up to ∞ flash readings (only one digit is displayed when the cumulated number is ten or more.)
  - Average function : up to 9 readings can be averaged.
  - Brightness Difference function : +/- 9.9 EV (in 1/10 stop)
  - Flash analyzing function : 0 to 100% in 10% increments
  - Exposure Out of Range : Eu (underexposure) or Eo (overexposure) indication
  - Exposure compensation : +/- 9.9 EV (in 1/10 stop)
  - Calibration compensation : +/- 1.0 EV (in 1/10 stop)
  - Battery Power Indicator display: with 3 level status icon
  - Auto Power Off : approx. 20 minutes after last use
  - Auto illumination : EV 6 and under
  - DIP switch mode selection
  - 1/4" Tripod socket : For placing meter in subject area for cordless flash measuring.
  - Second ISO film speed setting: ISO 3 to 8000 (in 1/3 stop)
  - Diopter adjustment : -2.5 to 1.0d
- Battery used : one of CR123A battery (lithium dry cell)
- Operating temperature range : -10 ~ 50°C
- Storage temperature range : -20 ~ 60°C
- Dimensions : 90 w × 170 h × 48 d mm
- Weight : 268 g (with battery)
- Standard accessories supplied : Soft case, strap, lens cap, synchro terminal cap, CR123A lithium battery × 1
- Radio triggering range : approx. 30 meters (approx. 100 feet)
- Radio wave frequency
- |          |           |                  |
|----------|-----------|------------------|
| FCC & IC | CH1 ~ 16  | 344.0MHz         |
|          | CH17 ~ 32 | 346.5 ~ 354.0MHz |
| CE       | CH1 ~ 16  | 433.62MHz        |
|          | CH17 ~ 32 | 434.22MHz        |

Features and specifications are subject to change without notice.

 WARNING:

- Please keep in a location where an infant cannot reach and accidentally get the strap wrapped around his neck. There is danger of strangulation.
- Never place batteries in fire, short, disassemble, or heat them. The batteries might break down, and cause injury or pollute the environment.

 CAUTION:

- Do not look directly at the sun through the viewfinder, because of potential eye injury.
- If you are operating the exposure meter in areas under wet conditions or high humidity, keep the sync post covered. If you are using flash in these conditions, Cordless Flash mode is recommended.

## 10. Care and Maintenance

### NOTE:

- Although this meter has an All-weather design for everyday use (JIS standard water resistance class 4), do not place it in water or use it underwater. This will cause it to malfunction.

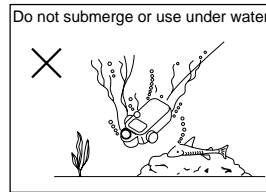
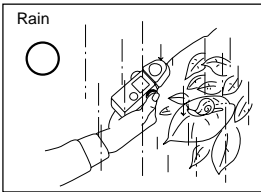
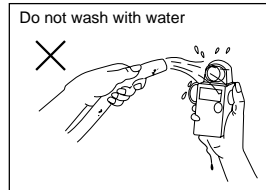
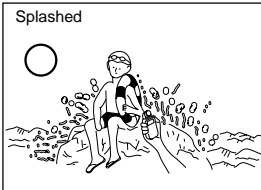

- To avoid damaging this meter, never drop it or subject it to shock.
- Avoid storing it in places with high temperatures or humidity.
- Avoid excessive temperature changes which could cause internal condensation, resulting in malfunction.

### Maintenance Notes

- If your meter is splashed with water, wipe immediately with a soft dry cloth.
- Avoid applying excessive force on the rubber seal of the battery compartment cover. Do not attempt to remove the rubber seal of the battery compartment cover.
- If the rubber seal's surface is damaged, water or moisture may enter and damage the meter. If this has happened, you must send your meter to the Sekonic Service Center in your country.
- Keep the surface of the Lumisphere and the front and rear surface of the Zoom lens free from dust, dirt, and scratches, which could affect accuracy.
- Never use organic cleaners (like thinner or benzene). Clean with soft dry cloth.



## FCC & IC compliance information:

---

Warning: Changes or modifications to this unit not expressly approved by the party responsible for compliance could void the user's authority to operate the equipment.

Note: This equipment has been tested and found to comply with the limits for a Class B digital device, pursuant

To Part 15 of the FCC Rules. These limits are designed to provide reasonable protection against harmful interference in a residential installation. This equipment generates, uses, and can radiate radio frequency energy and, if not installed and used in accordance with the instruction, may cause harmful interference to radio communication.

However, there is no guarantee that interference will not occur in a particular installation. If this equipment does cause harmful interference to radio or television reception, which can be determine by turning the equipment off and on, the user is encouraged to try to correct the interference by one or more of the following measures:

- \* Reorient or relocate the receiving antenna.
- \* Increase the separation between the equipment and receiver.
- \* Consult the dealer or an experienced radio/TV technician for help.

This device complies with Part 15 of the FCC rules and also with RSS-210 of Industry & Science Canada. Operation is subject to the following two condition: (1) This device may not cause harmful interference, and (2) this device must accept any interference received, including interference that may cause undesired operation.

FCC ID Number: PFK-608-01

Canada: 3916104181



## SEKONIC CORPORATION

7-24-14. Oizumi-Gakuen-cho, Nerima-ku, Tokyo 178-8686, Japan

Phone:++81-3-3978-2335 Facsimile:++81-3-3978-5229

## EU DECLARATION OF CONFORMITY

### THE EU DIRECTIVE COVERED BY THIS DECLARATION:

Radio & Telecommunications Terminal Equipment Directive 1999/5/EC

### PRODUCT COVERED BY THIS DECLARATION:

Name: Super Zoom Master

Model: L-608/L-608CINE

### THE BASIS ON WHICH CONFORMITY IS BEING DECLARED:

The Super Zoom Master L608/L-608CINE complies with the essential requirements of the Radio & Telecommunications Terminal Equipment Directive 1999/5/EC on the basis of Technical Construction File Number: R-3720N assessed by the Notified Body:

SGS EMC Services  
South Industrial Estate  
Bowburn  
Co. Durham DH6 5AD  
United Kingdom

**Printed Name: Makoto Tomono**

**Signed:** 

**Title: President**

**Date: April 20, 2001**

Note: The device makes use of a radio frequency and which is not harmonized throughout the EU.

# **SEKONIC CORPORATION**

7-24-14, OIZUMI-GAKUEN-CHO, NERIMA-KU, TOKYO 178-8686 JAPAN

TEL:+81(0)3-3978-2335 FAX:+81(0)3-3978-5229